

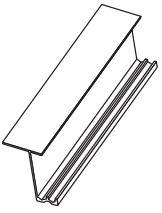

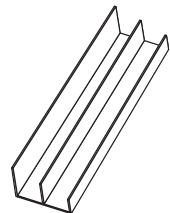
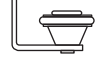

Wardrobe

1350mm

Light Oak Sliding Doors

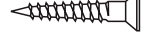
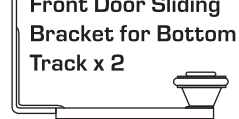
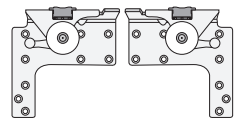
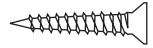
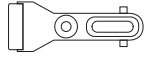
<p>Top Sliding Track x 1</p> 	<p>Bottom Sliding Track x 1</p> 	<p>Back Door Sliding Bracket for Bottom Track x 2</p> 	<p>Back Door Sliding Bracket for Top Track Set x 1</p> 	<p>14mm Wood Screws x 100</p> 
		<p>Front Door Sliding Bracket for Bottom Track x 2</p> 	<p>Front Door Sliding Bracket for Top Track Set x 1</p> 	<p>25mm Wood Screws x 4</p> 
				<p>Door Stopper x 4</p> 

STEP 1 IDENTIFYING TRACK HARDWARE

The sliding track hardware for the top of the doors consists of two brackets for a "front" door and two brackets for a "back" door.

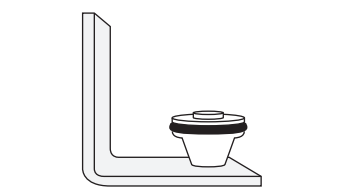
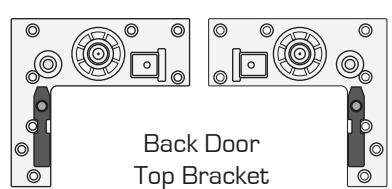
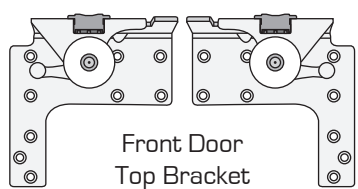

Back Door Bottom Bracket x 2

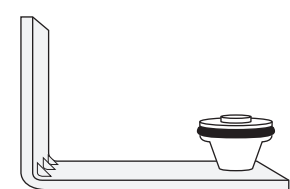

Front Door Bottom Bracket x 2

STEP 2 ATTACHING THE TOP BRACKET

Attach the top pieces of the sliding track hardware through the pre-drilled holes using the 14mm screws provided.

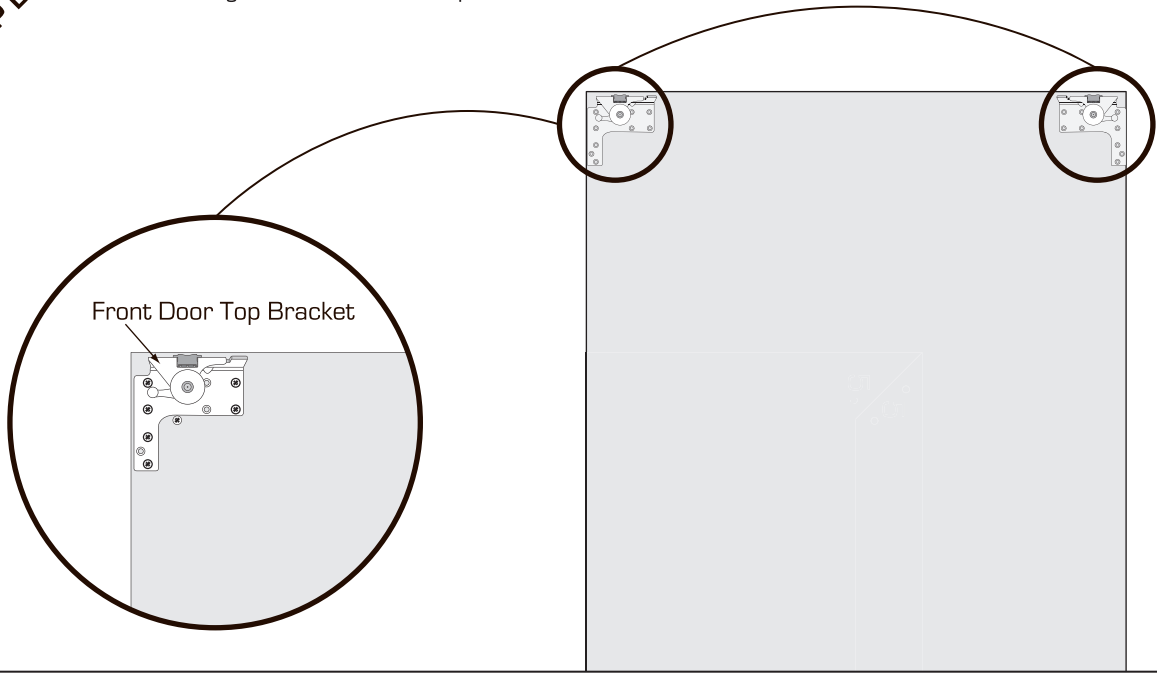

CAUTION ! Please ensure all cabinets are screwed into your timber stud wall using a minimum of 8 gauge, 65mm screws. If attaching to concrete, brick, steel or other sub surfaces seek advice from your hardware specialist. Please ensure you follow the installation and safety instructions located on your cabinet assembly instructions carefully.

For further enquiries visit www.flatpax.com.au or call customer service on 1800 666 078 Between 7:00am - 6:30pm E.S.T Mon - Fri

STEP 3
ATTACHING THE
BOTTOM BRACKET

Attach the bottom pieces of the sliding track hardware through the pre-drilled holes using the 14mm screws provided.

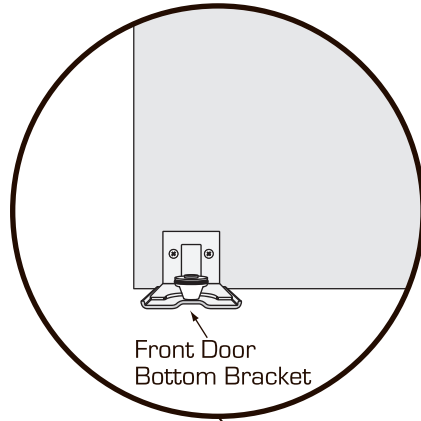

Front Door
Bottom Bracket



STEP 4
ATTACHING
TOP TRACK

Attach the top piece of the sliding track to the top of the cabinets through the pre-drilled holes using the 14mm screws.

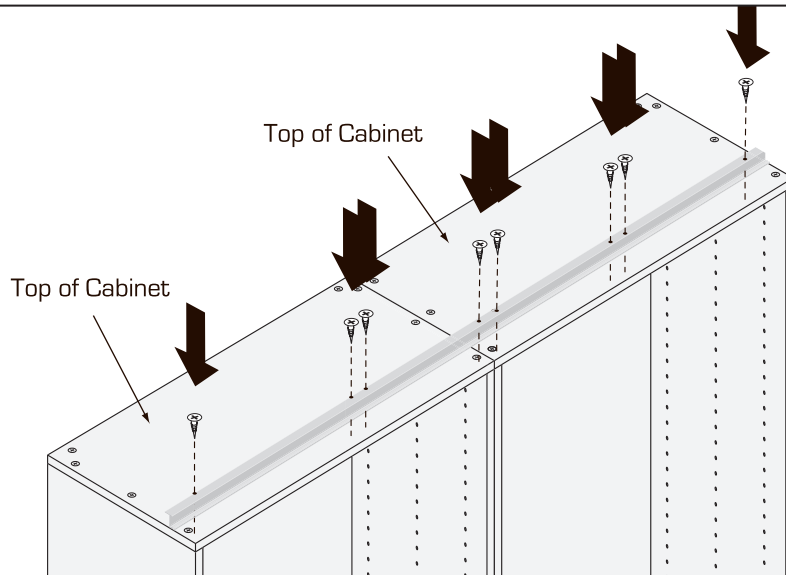

STEP 5
ATTACHING
BOTTOM TRACK

Attach the bottom piece of sliding track to the underside of the cabinet through the door stopper and into the pre-drilled holes using the 14 and 25mm screws.

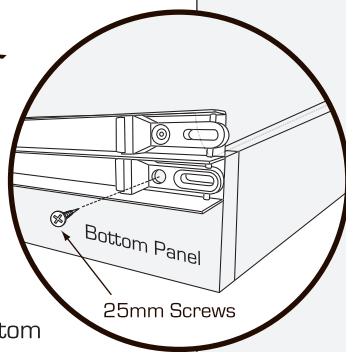

Bottom Panel
25mm Screws

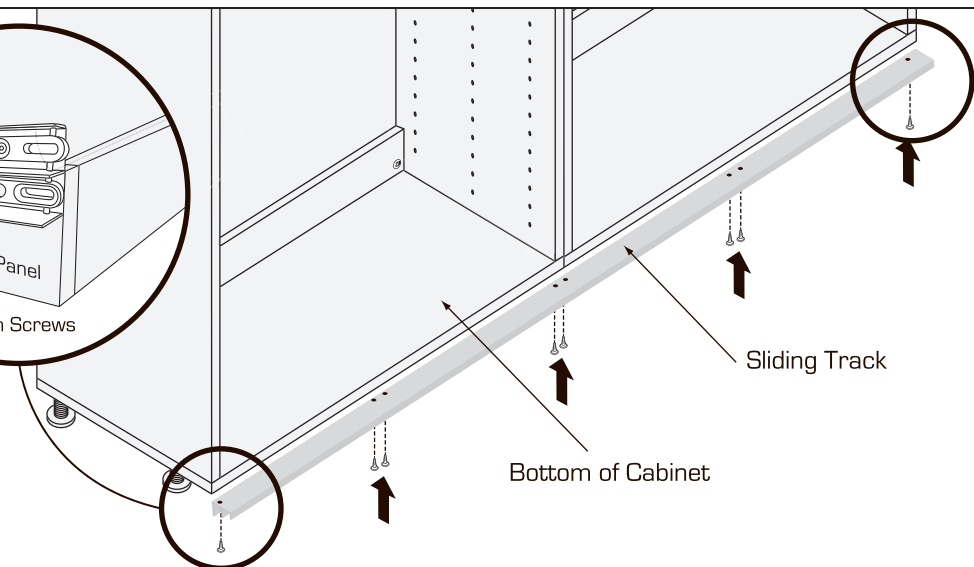

Sliding Track

Bottom of Cabinet

STEP 6
HANGING
BACK DOOR

Hang the back door first by lifting it up so the wheel at the bottom is inserted into the bottom track and then tilting it forward to place the top wheels on the top track (at the front) and lock into position.

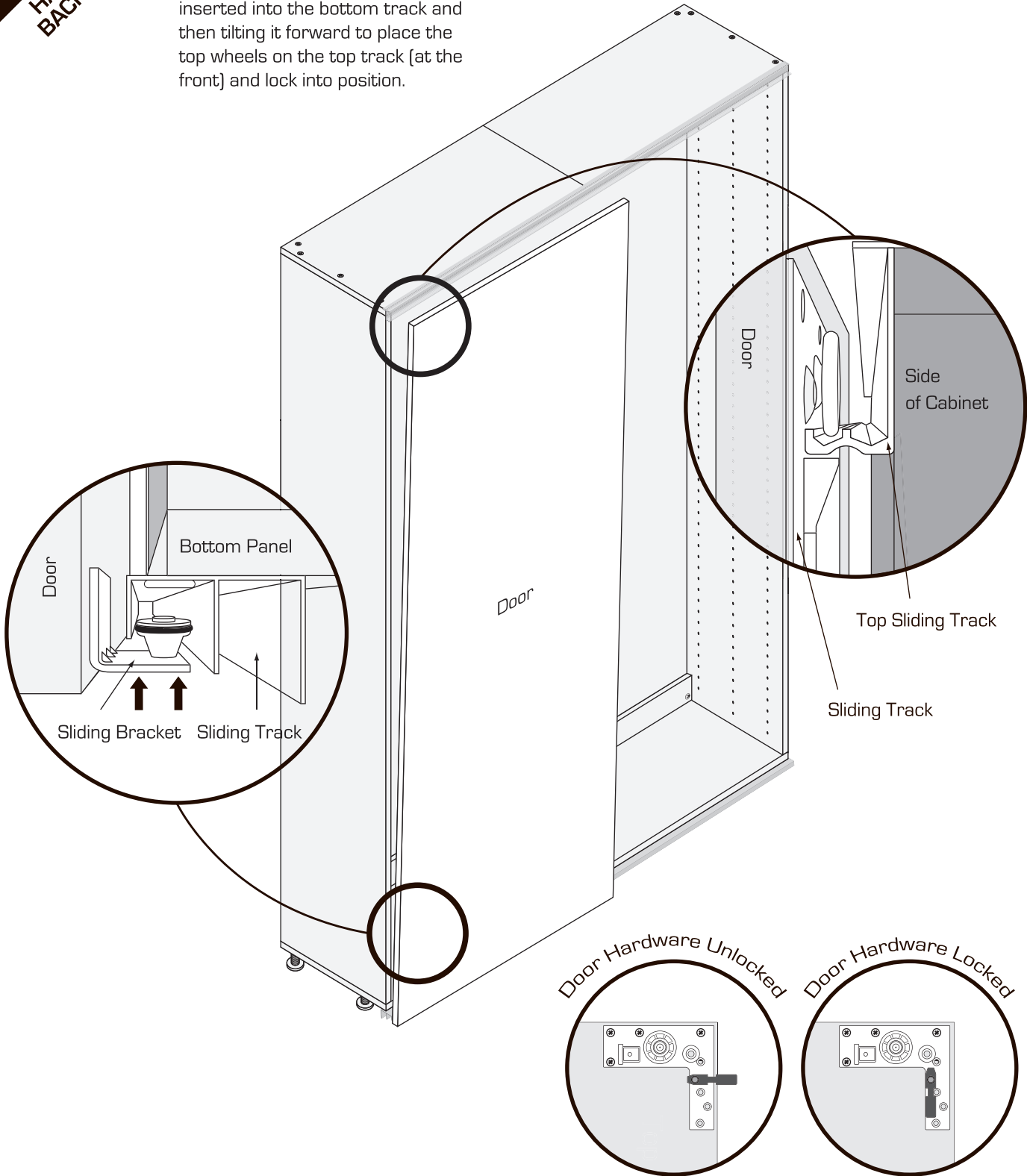

CAUTION ! Please ensure all cabinets are screwed into your timber stud wall using a minimum of 8 gauge, 65mm screws. If attaching to concrete, brick, steel or other sub surfaces seek advice from your hardware specialist. Please ensure you follow the installation and safety instructions located on your cabinet assembly instructions carefully.

For further enquiries visit www.flatpax.com.au or call customer service on 1800 666 078
Between 7:00am - 6:30pm E.S.T Mon - Fri

STEP 7
HANGING
FRONT DOOR

Hang the front door as per Step 6. Please ensure back door is pushed all the way to the right, then hang the front door to the left, as to not hit the other door. Position the wheels to the back of the sliding tracks and then lock them in.

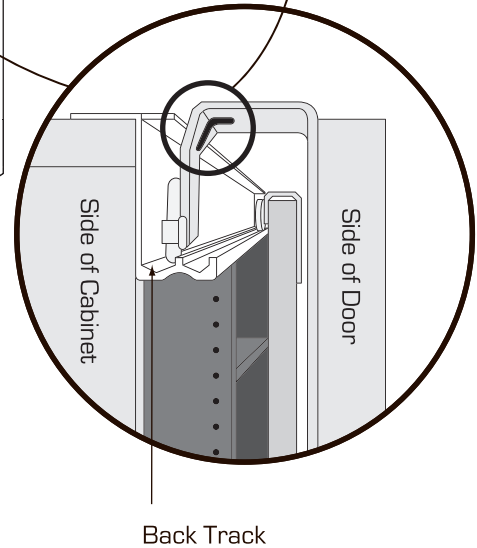
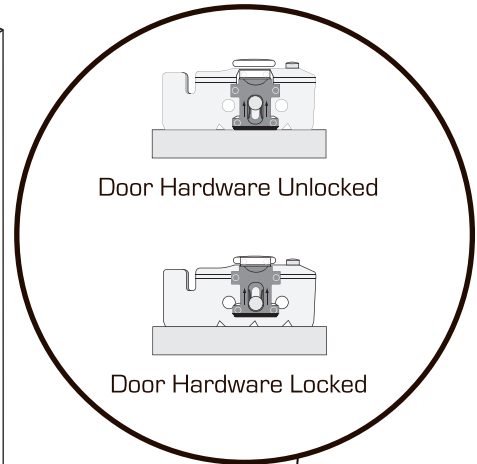
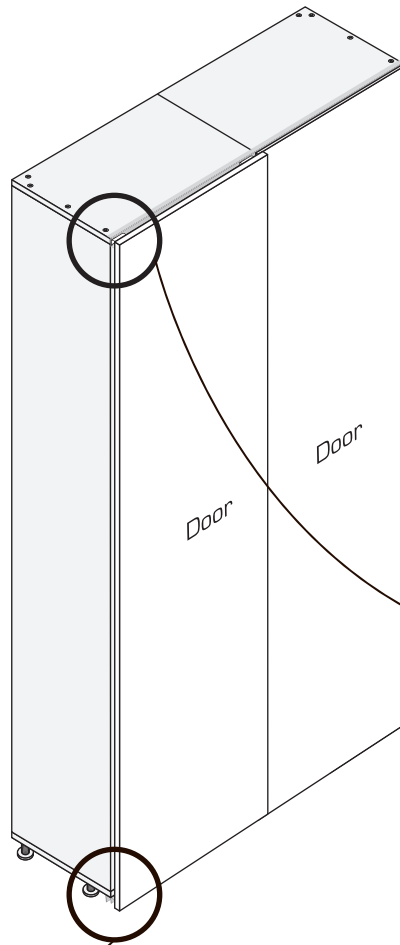
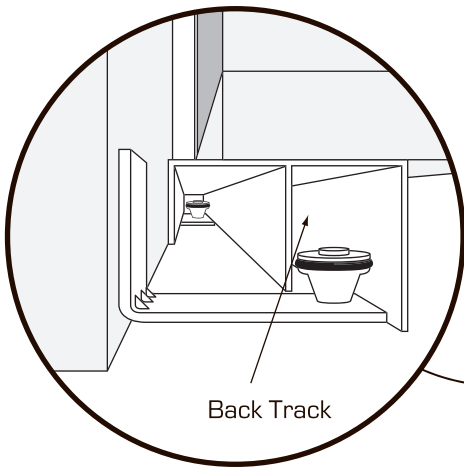

STEP 8
ATTACHING
END CAP

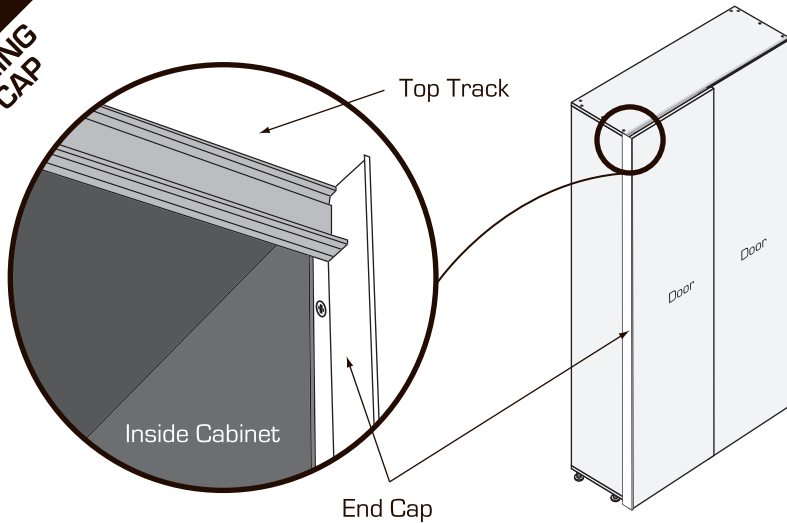

There are two pieces of "End Cap" to be attached to the ends of your wardrobe. Attach these to the front of the cabinets through the pre-drilled holes using the 14mm screws.



CAUTION ! Please ensure all cabinets are screwed into your timber stud wall using a minimum of 8 gauge, 65mm screws. If attaching to concrete, brick, steel or other sub surfaces seek advice from your hardware specialist. Please ensure you follow the installation and safety instructions located on your cabinet assembly instructions carefully.

For further enquiries visit www.flatpax.com.au or call customer service on 1800 666 078
Between 7:00am - 6:30pm E.S.T Mon - Fri